

PASS & SEYMOUR® Turnlok® Locking Devices Industrial Spec Grade Receptacles 15, 20 & 30A; 125 & 250V, 277VAC



Quality construction for maximum durability.

4710, 4700, 4792, 4560, 4550, 4760, 4750, L520, CRL520, L620, L720, L530, CRL530, L630, L730

Choose from a broad range of capacities in both single and duplex receptacle designs. They feature high-quality, brass contacts for rock-solid electrical connections and long service life. Single-piece, solid brass or steel straps and impact-resistant nylon face and body help them shrug off hard use.

Features & Benefits

Compact, impact-resistant nylon face and body are ultrasonically welded together for unrivaled strength.



Clearly marked NEMA configuration, rating and third party listing on each unit's face.

One-piece, high-grade brass contacts offer excellent conductivity and heat-rise resistance.



Side and external screw-pressure-plate back wire capability. Accepts #14 — #10 AWG.



Single-piece, solid brass mounting strap is free of easily loosened rivets found on other brands. 15 Amp mounting strap is steel.

L620R

3rd Party Compliance



UL Listed, File Number E146159, Standard UL498, Attachment Plugs and Receptacles. Federal Specification WC596.
CSA Certified, File Number LR1765, Standard CSA-C22.2 No. 42, General Use Receptacles and Attachment Plugs.
Conforms to NEMA WD-1 and WD-6.

Ordering Information

Catalog Number	Ratings		Description/Color	NEMA Config.
	A	V		
Receptacles Back & Side Wire				
4710	15	125	Single Receptacle, Black	L5-15R
4700	15	125	Duplex Receptacle, Black	L5-15R
4792	15	125	Combination Straight Blade and Locking, Black	5-15R and L5-15R
4560	15	250	Single Receptacle, Black	L6-15R
4550†	15	250	Duplex Receptacle, Black	L6-15R
4760	15	277*	Single Receptacle, Black	L7-15R
4750	15	277*	Duplex Receptacle, Black	L7-15R
4750	15	277*	Duplex Receptacle, Black	L7-15R
L520R	20	125	Single Receptacle, Black	L5-20R
L520RBL	20	125	Single Receptacle, Blue	L5-20R
L520RR	20	125	Single Receptacle, Red	L5-20R
CRL520R	20	125	Single Receptacle, Corrosion-Resistant, Yellow	L5-20R
L620R	20	250	Single Receptacle, Black	L6-20R
L620RBL	20	250	Single Receptacle, Blue	L6-20R
L620RR	20	250	Single Receptacle, Red	L6-20R
L720R	20	277*	Single Receptacle, Black	L7-20R
L530R	30	125	Single Receptacle, Black	L5-30R
L530RBL	20	125	Single Receptacle, Blue	L5-30R
L530RR	20	125	Single Receptacle, Red	L5-30R
CRL530R	30	125	Single Receptacle, Corrosion-Resistant, Yellow	L5-30R
L630R	30	250	Single Receptacle, Black	L6-30R
L630RBL	30	250	Single Receptacle, Blue	L6-30R
L630RR	30	250	Single Receptacle, Red	L6-30R
L730R	30	277*	Single Receptacle, Black	L7-30R

*AC only.

†Not designed for split circuits.

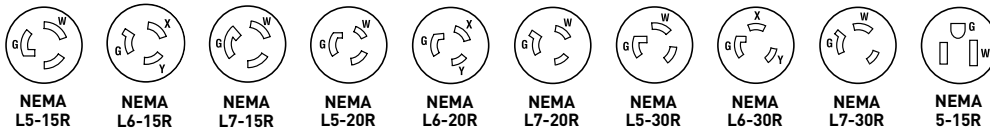

For more information on these and other P&S products refer to our Product Guide or visit our website.

Technical Specifications

Performance

Electrical	
Dielectric Withstand Voltage	2000V minimum
Maximum Working Voltage	600VAC
Current Interrupting	Certified for current interrupting at full-rated current
Temperature Rise	30°C max. after 50 cycles at 150% rated current
Mechanical	
Terminal Accommodation	#14 AWG min. – #10 AWG max.
Product Identification	Amperage, Voltage, NEMA Configuration molded into face
Environmental	
Flammability	UL94 V2
Operating Temperature	Maximum continuous +75°C, minimum -40°C without impact

Materials

	Standard	Corrosion-Resistant
Front Body	Nylon	Nylon
Back Body	Nylon	Nylon
Mounting Strap	15A = Steel, 20 & 30A = Brass	Nickel-Plated Brass
Pressure Plate	Brass	Nickel-Plated Brass
Contacts	Brass	Nickel-Plated Brass
Terminal Clamps	Brass	Nickel-Plated Brass
Terminal Screws	Brass	Brass
Mounting Screws	Zinc-Plated Steel	Stainless Steel

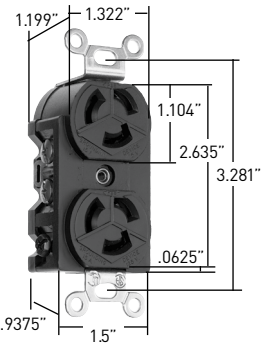

Dimensions for 4700



Dimensions for 4792

Warranty

1 Year

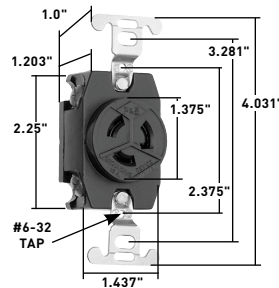

Dimensions for 4760

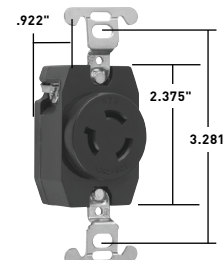

Dimensions for 4560

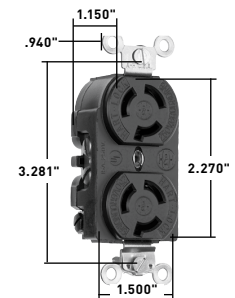

Dimensions for 4550

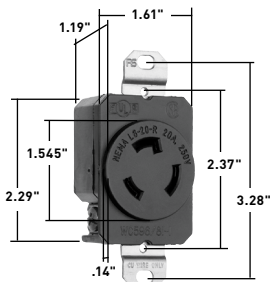

Dimensions for 20 Amp Receptacle

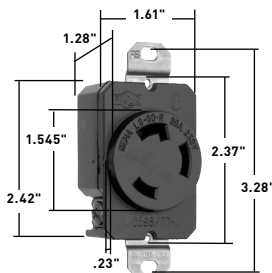

Dimensions for 30 Amp Receptacle

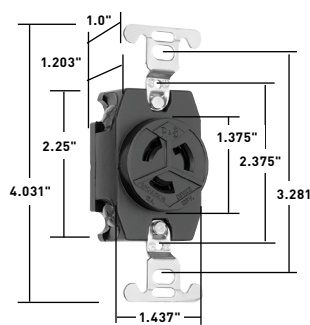

Dimensions for 4710

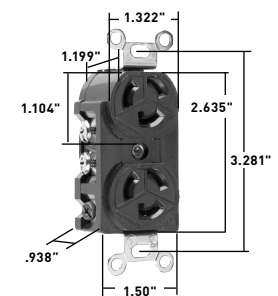

Dimensions for 4750

Also available

- USB Charging Devices
- The radiant® Collection
- Hospital Grade Devices
- PlugTail® Devices
- Switches
- Straight Blade Receptacles
- GFCIs
- Weatherproof Boxes & Covers
- IEC 309 Industrial Products
- Flexcor® Wire Mesh Grips
- Cable Reels



Bogotá Sala de Ventas

Carrera 12 No 13 - 46
PBX: 6013360755 - 6013412439
Celular: 312 3055335

Centro de Distribución

Carrera 18 No 19A - 36
PBX: 6013360755 EXT: 2101

